USER MANUAL

LED ZOOM MOVING HEAD LIGHT

(19*15W RGBW 4IN1 DMX 512 11/19/27CH)



Please read over this manual before operation the light

CONTENTS

Contents	0
Important notice1
Attention1
I. Product Illustration	2
II .The installment of led moving head2
III. The connection of control correspond wire	3
IV. Clean maintenance	4
V. Warning	5
VI. Difficult processing	5
VII. Equipment and appendix5
VIII. Technical paramet6

IX. Functional description	6
X. Functional description	6
XI. Panel operation	7
XII. DMX512channels	9

Important notice:

- In this instruction for use contains about the installment and the use aspect important information of the LED moving head. When installing and using, you need to look this usage instruction strictly.
- Before open the LED moving head and if you want to do the repair work, please make sure the power source is at the separation condition.

Attention:

Unceasingly carries on the product improvement about our company the policy, in this instruction booklet carries the data will have the possibility to be able to change in the future, when no longer separate notice change matters concerned. Our company retains when the product improvement changes the related specification the authority. This instruction booklet publisher cannot be responsible regarding this instruction booklet in information accuracy, also cannot the related consequence which causes regarding these information be responsible.

I. Product Illustration

Our product adopt semiconductor to produce radiation, LED as light origin. With advantage of operation quietly, less power waste, high brightness, gaily-colored, astigmatic, high longevity (60-100 thousands hours), non-calorific etc. Our product apply to use 3 kinds light as red, green, blue LED, synthesize turn colors under election, can create effect of auto

gradual change/skip change color, frequent blinking. Can accept control by DMX512, real save power, no pollution green lighting tool.

II .The installment of led moving head

Use the four bolts with M8 size by the clip of the LED moving head to install it. Should guarantee the reliability of the install, this way is to prevent the LED moving head occur swings and skids when it's working. The weight is about 8Kg of each LED moving head, before install, you should confirm the structure whether can support this weight of the LED moving head light. In order to guarantee the security, you also need to install a safety chain in the lamp body side handle.②

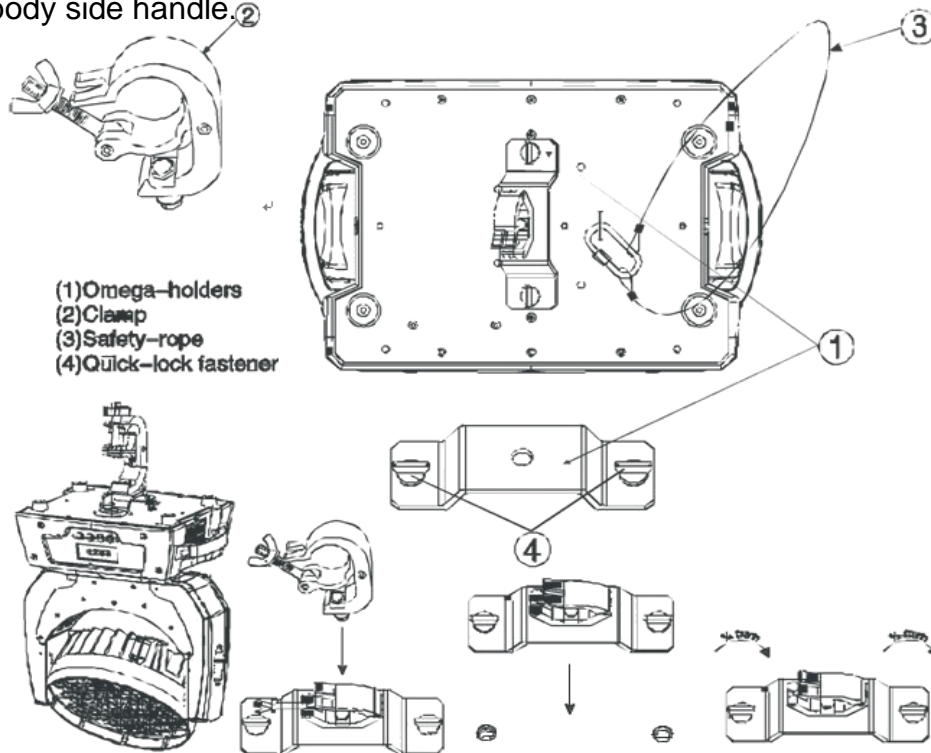

Warning: Do not use the hand of the LED moving head to up and down or fix.

III. The connection of control correspond wire

The connection of controller between the led moving head lamp and respectively led moving head lamp should use the twin core shielded cable, and the diameter of each core at

least be 0.3mm. After receives the DMX512 signal, the lamp of nearby the address switch condition will glisten. When it's do not receive the DMX signal, the lamp will in extinguish condition, but if the signal lamp glisten continuously, the mean is the DMX signal is not be correct.

When installing, uses the DMX signal terminal is much better. It can avoid the digital control signal breached by the electrical noise. Generally speaking, the DMX terminal is Cannon plug coupling, it has a 120 ohm resistances between the 2 feet and 3 feet, it will connected on the last led moving head lamp's digital plug of the led moving head lamp chain.

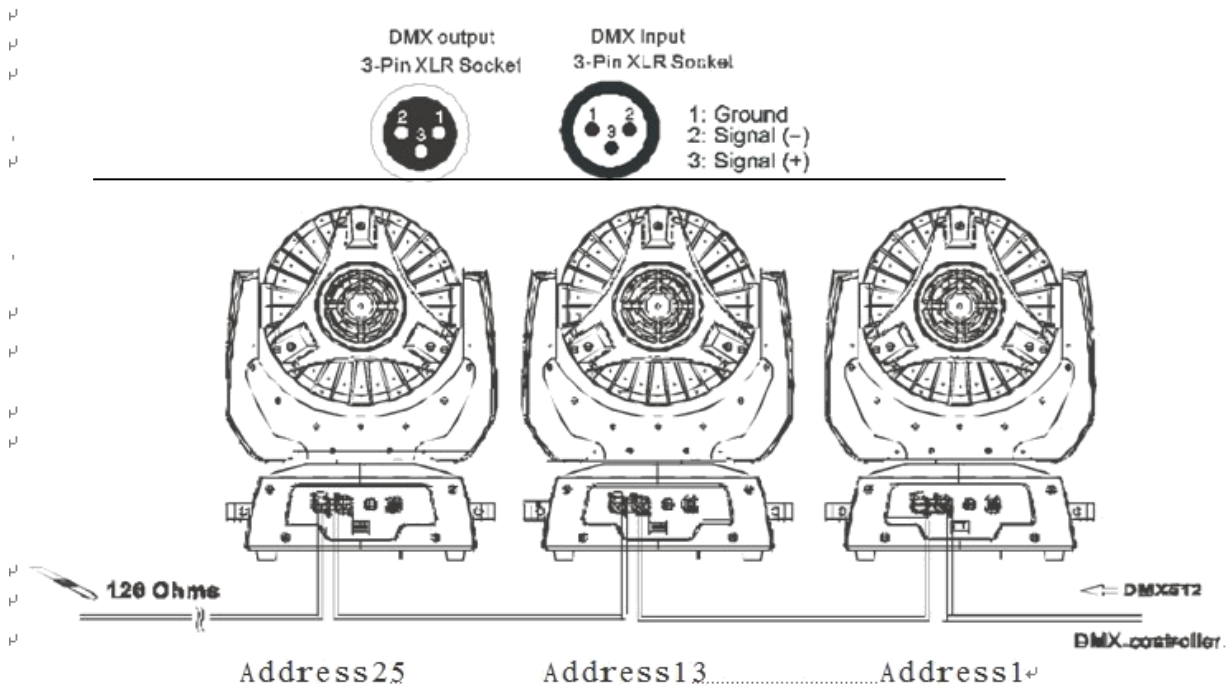

Connecting DMX512 digital signal,

Please using high quality screen line to connect it, for fear interfering.

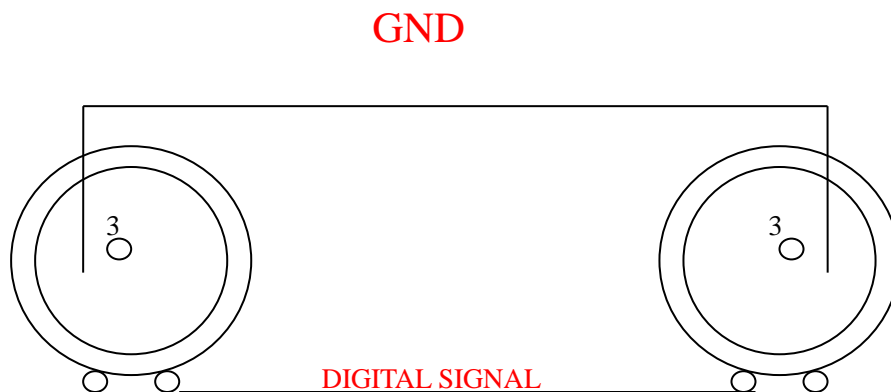

IV. the connection of Power Cable

Use the provided plug to connect the main power to the projector paying attention to the voltage and frequency marked on the panel of the projector. It is recommended that each projector be supplied separately so that they may be individually switched on and off.

IMPORTANT

It is essential that each projector is correctly earthed and that electrical installation conforms to all relevant standards. Power consumption of this projector is 200VA.

The connection of Power cable between the led moving head lamp and respectively led moving head lamp should use the three core shielded cable,

Power cable joint (at most 4pcs) in each other, this is the Connector picture as below:

Important Notice:

In order to avoid overloading the power supply, the power cable can only supply power for at most 4 light

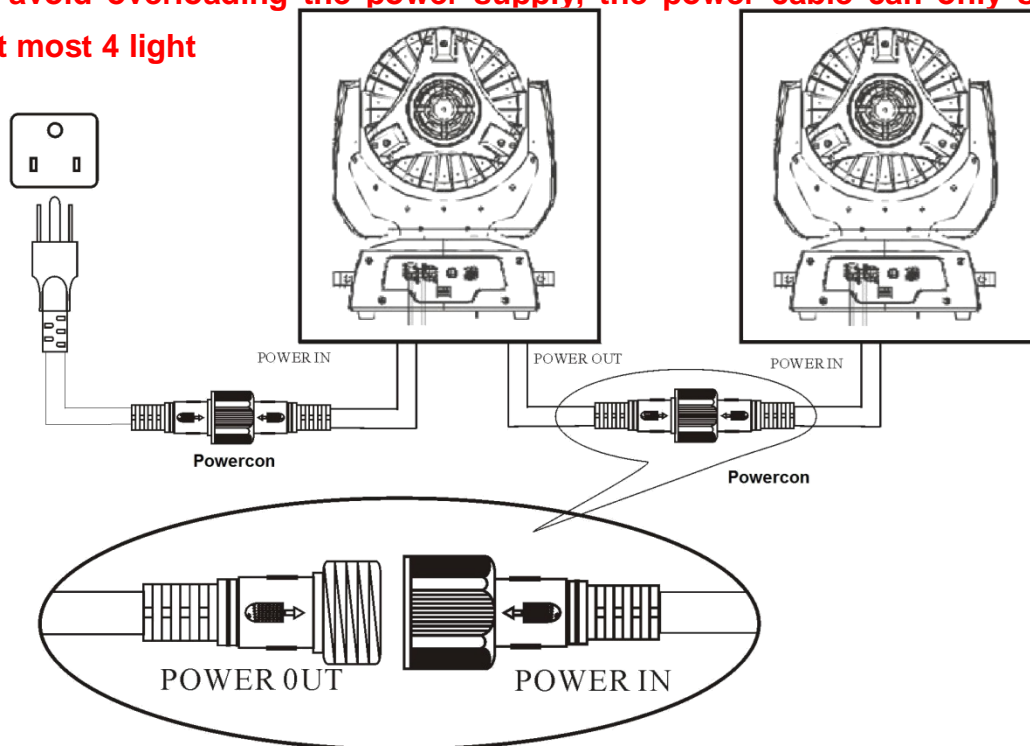

V. Clean maintenance

In order to guarantee the LED moving head lamp can work better, you should keep the lamp in clean state. Suggests clean the lamp body and fan in each 15 days. For the PVS board, you need clean it on time. When you cleaning the PVC piece, please do not use any soluble cleanser,

VI. Warning

- Don't disassemble and assemble the LED moving head.
- Please do not put the led moving head lamp in water or other any type's liquids and the

metal (IP20).

- Do not install the led moving head lamp in the humidity environment.
- Should maintain the minimum 0.5 meter distance between the led moving head lamp and other neighboring object surface.

VII. Difficult processing

Question	Answer
The LED moving head lamp can not start.	Inspects the fuse on the rear panel.
Although shines, but the LED moving head lamp can not accept the instruction of the controller.	Check the digital start address (sees 09th) and also check the connection situation of the communication control line the (to see 03rd).
LED moving head lamp only can work intermittently.	Inspect the power supply and voltage is whether normal.
Do not receive the DMX512 signal	Whether the signal lines do contact good or broken
The light beam appears gloomily.	Inspect the optics part is whether clean.

Other maintains work should by the specialist which has the experience to carry on.

VII. Equipment and appendix

1 led moving head lamp

1PCE

2 the product of USER MANUAL	1PCE
3 Power source connected lines	1PCE
4 signal lines	1PCE

VIII. Technical parameters

Voltage / frequency: □90-130V/□, √ 180V-240V/50-60Hz

Bulbs: 19*15W RGBW

Power:300 W

Control signal: DMX 512, in sets at the automatic procedure

Channel: 11/19/27CH, DMX512 channel control

Motion: level 540°, vertical 280°, horizontal and vertical uses the electronic replacement function

Color: 16.7 million kinds of colors changes

Adjusts the light: 0-100 electron adjusts the light, various colors may alone move also may mix the color tone

Strobe: 1-25/second high speed strobe, but single color mixes the color strobe

ZOOM angel: 105-30degree adjust

IX. Functional description

Ccontroller can control Moving head light's three axes (PAN axis, TITL axis and Zoom axis), The light have RGBW 4IN1 Multi-Chip LED Lamp, and 3IN1 Tricolor RGB LED Moving Head, and 3color and 4 color, it have DMX mode (can be set DMX address), self-propelled mode (can be set up master-slave), Sound mode (can be set master / slave), The mode selection can be set by the panel or DMX 512 controller (this must be set to DMX mode); The light also have strobe / random frequency flash / strobe out fast and slow / slow forward faster strobe mode, the color jump / gradients

X. Functional Setting



1. Fast operation settings

Controller can quickly set the light's mode, the main interface, followed by "ESC" key to select DMX mode, Auto mode or sound-activated mode,

- In DMX mode: Press "UP" "DOWN" to optional DMX address;
- In the self-propelled mode: Press "UP" "DOWN" to choose master or slave;
- In the sound mode: Press "UP" "DOWN" to choose master or slave

|

X I . Panel operation

	Menu	1. XY Reverse	Pan	YES--NO
			Tilt	YES--NO
		2. Mic Sense	0--100	
		3. Reset	YES--NO	
		4. Default	YES--NO	
	5. Factory Set			
	Addr	d001-d512		
	Disp	disp - dsip		
	En/CH	English/chinese		
	Mode	DMX512		

		Auto 1
		Auto 2
	11CH/1 9CH/27 CH	11 Channels
		19 Channels
		27 Channels

3. DMX channel function

27 Channel:

CH 1:	Pan	Pan	0----255
CH 2:	Pan fine	Pan fine	0----255
CH 3:	tilt	tilt	0----255
CH 4:	tilt fine	tilt fine	0----255
CH 5:	pan/tilt speed	rotate fast to slow	0----255
CH 6:	zoom	Focusing distance from far to near	0----255
CH 7:	general dimmer	get dark to bright	0----255
CH 8:	strobe	no effect	0----15
		strobe from slow to fast	16----215
		Random strobe	216----255
CH 9:	dimmer mode	mode 1	0----49
		mode 2	50----99
		mode 3	100----149
		mode 4	150----199
		mode 5	200----255
CH 10:	R1	get dark to bright	0----255

CH 11:	G1	get dark to bright	0----255
CH 12:	B1	get dark to bright	0----255
CH 13:	W1	get dark to bright	0----255
CH 14:	R2	get dark to bright	0----255
CH 15:	G2	get dark to bright	0----255
CH 16:	B2	get dark to bright	0----255
CH 17:	W2	get dark to bright	0----255
CH 18:	R3	get dark to bright	0----255
CH 19:	G3	get dark to bright	0----255
CH 20:	B3	get dark to bright	0----255
CH 21:	W3	get dark to bright	0----255
CH 22:	macro color	no effect	0----15
		R100%,G UP,B0%	16----35
		R DOWM,G100%,B0%	36----55
		R0%,G100%,B UP	56----75
		R0%,G DOWM,B100%	76----95
		R UP,G0%,B100%	96----115
		R100%,G0%,B DOWM	116----135
		R100%,G UP,B UP	136----155
		R DOWM,G DOWM,B100%	156----175
		R 100%,G 100%,B100%,W100%	176----195
CH 23:	LEDs effect	no effect	0----9
		Static effect (one effect at three value intervals)	10----99
		Dynamic effects1	100----149
		Dynamic effects2	150----255

CH 24:	LEDs effect speed	rotate fast to slow	0----255
CH 25:	pattern effect	static pattern 1	0----9
		static pattern 2	10----19
		static pattern 3	20----29
		static pattern 4	30----39
		static pattern 5	40----49
		static pattern 6	50----59
		static pattern 7	60----69
		static pattern 8	70----79
		static pattern 9	80----89
		static pattern 10	90----99
		static pattern 11	100----109
		static pattern 12	110----119
		static pattern 13	120----129
		static pattern 14	130----139
		static pattern 15	140----149
		static pattern 16	150----159
		dynamic pattern 1	160----169
		dynamic pattern 2	170----179
		dynamic pattern 3	180----189
		dynamic pattern 4	190----199
dynamic pattern 5	200----209		
dynamic pattern 6	210----219		
dynamic pattern 7	220----229		
dynamic pattern 8	230----255		
CH 26:	pattern transformation		0----255

	speed		
CH 27:	reset	no effect	0----127
		Auto 1	
		Auto 2	
		Auto 3	
		reset	128----255

19 Channel:

CH 1:	Pan	Pan	0----255
CH 2:	Pan fine	Pan fine	0----255
CH 3:	tilt	tilt	0----255
CH 4:	tilt fine	tilt fine	0----255
CH 5:	pan/tilt speed	rotate fast to slow	0----255
CH 6:	zoom	Focusing distance from far to near	0----255
CH 7:	general dimmer	get dark to bright	0----255
CH 8:	strobe	no effect	0----15
		strobe from slow to fast	16----215
		Random strobe	216----255
CH 9:	dimmer mode	mode 1	0----49
		mode 2	50----99
		mode 3	100----149
		mode 4	150----199
		mode 5	200----255
CH 10:	R	get dark to bright	0----255

CH 11:	G	get dark to bright	0----255
CH 12:	B	get dark to bright	0----255
CH 13:	W	get dark to bright	0----255
CH 14:	macro color	no effect	0----15
		R100%,G UP,B0%	16----35
		R DOWM,G100%,B0%	36----55
		R0%,G100%,B UP	56----75
		R0%,G DOWM,B100%	76----95
		R UP,G0%,B100%	96----115
		R100%,G0%,B DOWM	116----135
		R100%,G UP,B UP	136----155
		R DOWM,G DOWM,B100%	156----175
		R 100%,G 100%,B100%,W100%	176----195
CH 15:	LEDs effect	no effect	0----9
		Static effect (one effect at three value intervals)	10----99
		Dynamic effects1	100----149
		Dynamic effects2	150----255
CH 16:	LEDs effect speed	rotate fast to slow	0----255
CH 17:	pattern effect	static pattern 1	0----9
		static pattern 2	10----19
		static pattern 3	20----29
		static pattern 4	30----39
		static pattern 5	40----49
		static pattern 6	50----59
		static pattern 7	60----69

		static pattern 8	70----79
		static pattern 9	80----89
		static pattern 10	90----99
		static pattern 11	100----109
		static pattern 12	110----119
		static pattern 13	120----129
		static pattern 14	130----139
		static pattern 15	140----149
		static pattern 16	150----159
		dynamic pattern 1	160----169
		dynamic pattern 2	170----179
		dynamic pattern 3	180----189
		dynamic pattern 4	190----199
		dynamic pattern 5	200----209
		dynamic pattern 6	210----219
		dynamic pattern 7	220----229
		dynamic pattern 8	230----255
CH 18:	pattern transformation speed		0----255
CH 19:	reset	no effect	0----127
		Auto 1	
		Auto 2	
		Auto 3	
		reset	128----255

11 Channel:

CH 1:	Pan	Pan	0----255
CH 2:	tilt	tilt	0----255
CH 3:	pan/tilt speed	rotate fast to slow	0----255
CH 4:	zoom	Focusing distance from far to near	0----255
CH 5:	general dimmer	get dark to bright	0----255
CH 6:	strobe	no effect	0----15
		strobe from slow to fast	16----215
		Random strobe	216----255
CH 7:	LEDs effect	no effect	0----9
		Static effect (one effect at three value intervals)	10----99
		Dynamic effects1	100----149
		Dynamic effects2	150----255
CH 8:	LEDs effect speed	rotate fast to slow	0----255
CH 9:	pattern effect	static pattern 1	0----9
		static pattern 2	10----19
		static pattern 3	20----29
		static pattern 4	30----39
		static pattern 5	40----49
		static pattern 6	50----59
		static pattern 7	60----69
		static pattern 8	70----79
		static pattern 9	80----89
		static pattern 10	90----99

		static pattern 11	100----109
		static pattern 12	110----119
		static pattern 13	120----129
		static pattern 14	130----139
		static pattern 15	140----149
		static pattern 16	150----159
		dynamic pattern 1	160----169
		dynamic pattern 2	170----179
		dynamic pattern 3	180----189
		dynamic pattern 4	190----199
		dynamic pattern 5	200----209
		dynamic pattern 6	210----219
		dynamic pattern 7	220----229
		dynamic pattern 8	230----255
CH 10:	pattern transformation speed		0----255
CH 11:	reset	no effect	0----127
		Auto 1	
		Auto 2	
		Auto 3	
		reset	128----255

Powered on LED Moving light, connect it to the DMX controller, after receiving the DMX signal, the signal mark X disappeared, then light is under DMX controller's control.

Under DMX Mode,connecting multiple lights together,but disconnect with DMX controller, all lights can work in the same step. When connected the first one to controller, the whole group can move in the same step under DMX controller's control.